

1" GRIP WHEEL - 1/2" HEX BORE

PART NUMBER	DUROMETER	COLOR
REV-21-2048	30A	LIGHT GRAY
REV-21-2047	45A	GRAY
REV-21-2024	60A	BLACK

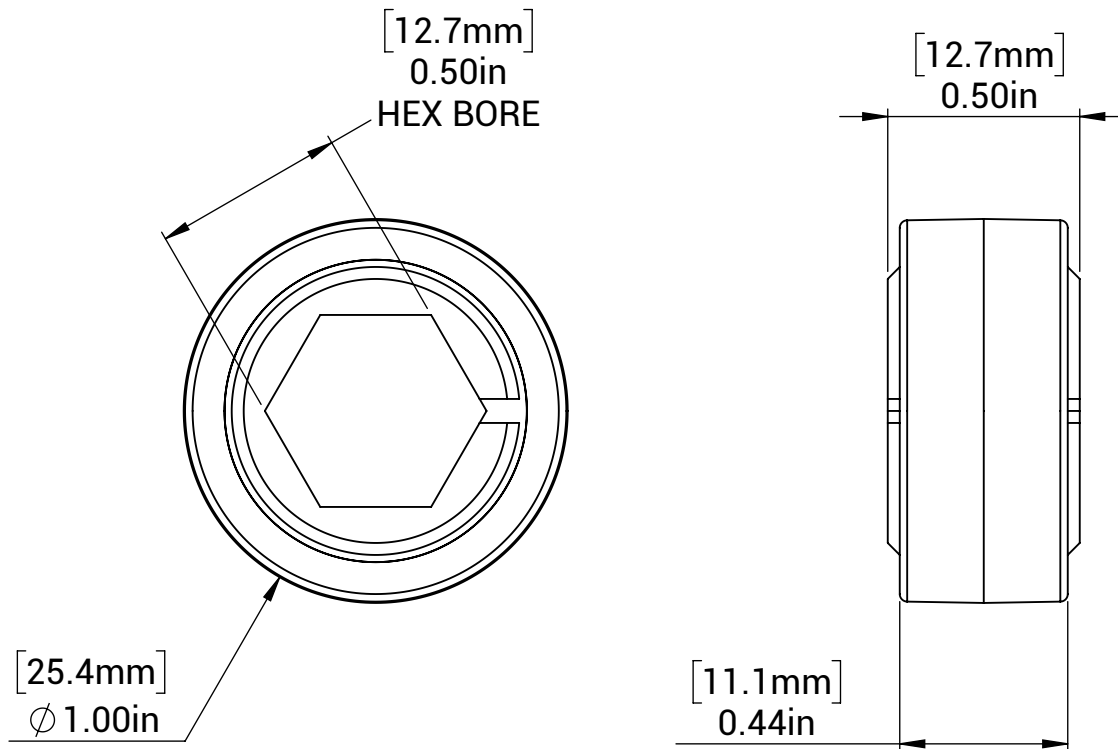

MM SHEET TOLERANCES:
 X ± 0.50 MM
 X.X ± 0.10 MM
 X.XX ± 0.05 MM
 ANGLES $\pm 2^\circ$

INCH SHEET TOLERANCES:
 X ± 0.1 IN
 X.X ± 0.02 IN
 X.XX ± 0.004 IN
 X.XXX ± 0.002 IN
 ANGLES $\pm 2^\circ$

MATERIAL:

CORE - POLYPROPYLENE
 OVERMOLD - TPU

DATE: 2/12/2021